

ROYAL 
BOTANIA
indulge in finesse

OUTDOOR LIGHTING COLLECTION

At night, a property and its surroundings can take on a whole new look thanks to outdoor lighting. You can make your driveways and entrance paths more inviting to guests and less attractive to unwanted intruders. Parts of your buildings, walls, trees and flowerbeds can be highlighted in subtle or more dynamic ways.

WHY DO DISCERNING PEOPLE CHOOSE ROYAL BOTANIA?

There are three main reasons: quality, harmony and design. With the range of lighting options from Royal Botania, you can make your statement with an aesthetic that speaks for you. Choose from our modern and traditional designs, all of which are made from the finest and most durable materials, and incorporate the latest in lighting technology. Royal Botania premium outdoor lighting is beautiful, practical and flexible, with many of our reading lamps and highlighting pieces being just as suitable for indoor use too.

All our models are made from the highest quality materials. Whether aluminum, glass, stainless steel or teak, every material used to make Royal Botania products is sourced for its purity, durability and perfect aesthetics. But what makes some designs a cut above others? Is it to do with an eye for symmetry, scale and shapes? Is it to do with colors and curves and straight lines? Is it about simplicity and minimalism, and being influenced by the best of the past to create something new? It is very hard to explain why Royal Botania designs work so well, but when you see them, you just know they do.



OUTDOOR LIGHTING

6	Beacon	56	Q-Bic Wall
8	Beacon Wall	58	Ropy
12	Beamy	60	Ropy Table
14	Beamy Wall	64	Rusty
16	Bullet	66	Spiky
18	Cloche Wall	68	Spiky Lounge
20	Club Lounge	70	Spotty Spike
22	Dome Ceiling	74	Spotty Wall
24	Dome Floor	76	Tesla Ceiling
26	Dome Gate	80	Tesla Wall
28	Dome Move	82	Tristar
30	Dome Small	84	Tristar Alu
32	Dome Wall	88	Accessories
34	Dome Glass Varieties	89	Materials
36	Ellipse Wall		
38	Moso Ground		
40	Moso Wall		
42	Neptune		
46	Omega		
48	Parker Flood		
52	Parker Path		
54	Parker Wall		

AVAILABILITY OF PRODUCTS









STANDARD

Of these products we keep an inventory based on expected sales quantities.

*

You will notice that some product references are marked with an asterisk (*). This indicates that the product is only available “while stocks last”. Consult us for more information or stock.

SYMBOLS

	Protected against objects > 1mm & protected against water sprayed at max. angle 60°
	Protected against objects > 1mm & water projections from all directions (360°)
	Protected against dust & against water sprayed from all directions (360°)
	Totally sealed against dust & against water sprayed from all directions (360°)
	Totally sealed against dust & protected against permanent immersion
	Protective category 1
	Protective category 2
	Protective category 3

BEACON

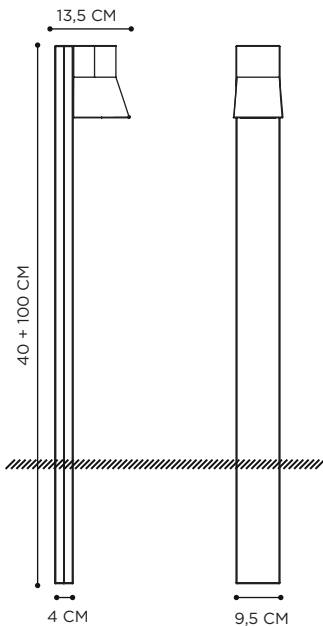

TECHNICAL INFO

REFERENCE

BCN140B
BCN140W

DIMENSIONS

WIDTH 9,5 CM
DEPTH 13,5 CM
HEIGHT 140 CM

MATERIALS



TEAK + PORCELAIN BLACK

TEAK + PORCELAIN WHITE

LIGHT SOURCE

LAMP LED - 2,2W
POWER SUPPLY 250mA DRIVER INCLUDED
IN FIXTURE
POWER IN 100-240V - 50/60Hz
LIGHT OUTPUT 390LM
COLOR TEMPERATURE 2700K
IP-RATING IP65
INSTALLATION OPTION JUB5625





BEACON WALL



TECHNICAL INFO

REFERENCE

BCNWB
BCNWW

DIMENSIONS

WIDTH 10,5 CM
DEPTH 12,5 CM
HEIGHT 15,5 CM

MATERIALS



TEAK + PORCELAIN BLACK



TEAK + PORCELAIN WHITE

LIGHT SOURCE

LAMP LED - 2,2W
POWER SUPPLY 250mA DRIVER INCLUDED
IN FIXTURE
POWER IN 100-240V - 50/60Hz
LIGHT OUTPUT 390LM
COLOR TEMPERATURE 2700K
IP-RATING IP65

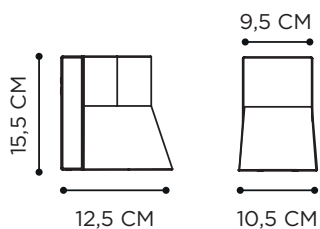









BEAMY



TECHNICAL INFO

REFERENCE

BMY100220
BMY100Z220

DIMENSIONS

WIDTH 12 CM
DEPTH 13 CM
HEIGHT 100 CM

MATERIALS



TEAK + ANTIQUE BRASS



TEAK + ZINC

RECOMMENDED LIGHT SOURCE

LAMP LED - 5W - GU10 - FLAT OPTIC
POWER IN 230V
IP-RATING IP44
INSTALLATION OPTION JUB5625

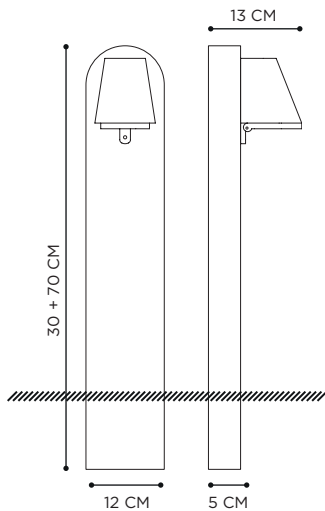

BEAMY WALL

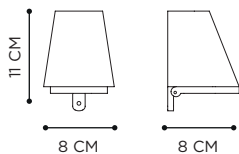

TECHNICAL INFO

REFERENCE

BMYW220
BMYWZ220

DIMENSIONS

WIDTH 8 CM
DEPTH 8 CM
HEIGHT 11 CM

MATERIALS



ANTIQUE BRASS



ZINC

RECOMMENDED LIGHT SOURCE

LAMP LED - 5W - GU10 - FLAT OPTIC
POWER IN 230V
IP-RATING IP44





BULLET

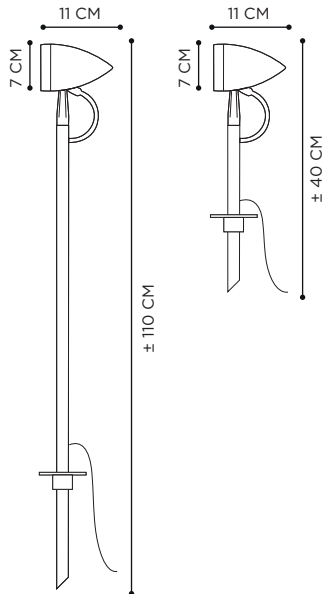

TECHNICAL INFO

REFERENCE

BLTL / BLTLG

DIMENSIONS

WIDTH	7 CM
DEPTH	11 CM
HEIGHT	± 40 CM / ± 110 CM

MATERIALS



ZINC

ANTIQUÉ BRASS

LIGHT SOURCE

LAMP	LED 3W
LIGHT OUTPUT	500LM
COLOR TEMPERATURE	2700K
IP-RATING	IP55
EXTRA	ADJUSTABLE HEAD
REQUIRED	LEDCONKIT OR DR11







CLOCHE WALL



TECHNICAL INFO

REFERENCE

CLOW

DIMENSIONS

WIDTH	12 CM
DEPTH	18,5 CM
HEIGHT	25 CM

MATERIALS



TEAK + HANDMADE
CLEAR GLASS

LIGHT SOURCE

LAMP	4W - DECORATIVE LED FILAMENT BULB INCLUDED
POWER IN	230V - E27
LIGHT OUTPUT	280LM
COLOR TEMPERATURE	2200K
IP-RATING	IP54

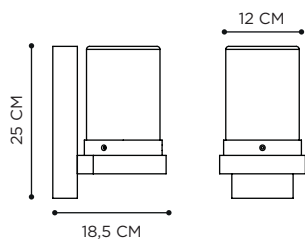



CLUB LOUNGE

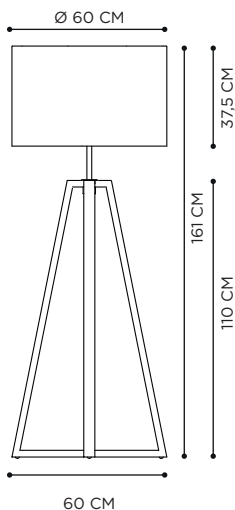

TECHNICAL INFO

REFERENCE

CLBLTR / CLBLAM (LED)
CLBLSTR / CLBLSAM (SOLAR)

DIMENSIONS

WIDTH 60 CM
DEPTH 60 CM
HEIGHT 161,5 CM

MATERIALS



TEAK + STAINLESS STEEL (EP)
BEIGE SHADE

TEAK + STAINLESS STEEL (EP)
AMBER SHADE

LIGHT SOURCE LED

LAMP LED 4,3W
POWER SUPPLY 500mA DRIVER INCLUDED
IN FIXTURE
LIGHT OUTPUT 700LM
COLOR TEMPERATURE 2700K
IP-RATING IP65



LIGHT SOURCE SOLAR

LAMP SOLAR LED 2,6W
RECHARGEABLE VIA USB
LIGHT OUTPUT 400LM
COLOR TEMPERATURE 2700K
IP-RATING IP65





DOME CEILING



TECHNICAL INFO

REFERENCE

DOMECBCL
DOMECBSM
DOMECBAM
DOMECLBCL
DOMECLBSM
DOMECLBAM

DIMENSIONS

WIDTH 30 CM
DEPTH 30 CM
HEIGHT 44 CM + 49-84 CM - SHORT
44 CM + 74-134 CM - LONG

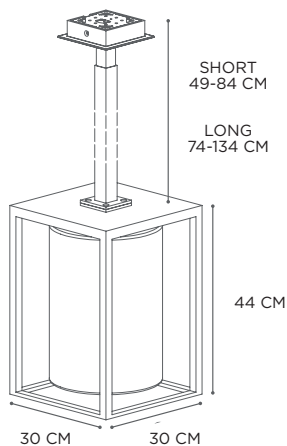

MATERIALS



POWDER COATED ALUMINIUM
ANTHRACITE



HANDMADE GLASS
CLEAR / SMOKE / AMBER

LIGHT SOURCE

LAMP 4W - DECORATIVE LED
FILAMENT BULB INCLUDED
POWER IN 230V - E27
LIGHT OUTPUT 280LM
COLOR TEMPERATURE 2200K
IP-RATING IP43





DOME FLOOR



TECHNICAL INFO

REFERENCE

DOMEFBCL
DOMEFBSM
DOMEFBAM
DOMEFWCL
DOMEFWSM
DOMEFWAM

DIMENSIONS

WIDTH 33 CM
DEPTH 23 CM
HEIGHT 171 CM

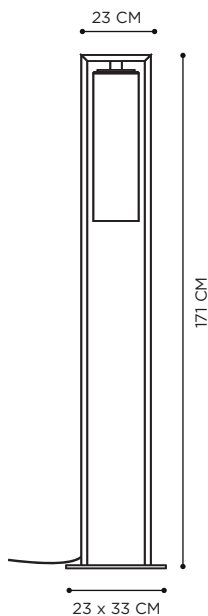

MATERIALS



POWDER COATED ALUMINIUM
ANTHRACITE OR WHITE FRAME



HANDMADE GLASS
CLEAR / SMOKE / AMBER

LIGHT SOURCE

LAMP 4W - DECORATIVE LED
FILAMENT BULB INCLUDED
POWER IN 230V - E27
LIGHT OUTPUT 280LM
COLOR TEMPERATURE 2200K
IP-RATING IP43

INSTALLATION OPTION JUB5625



DOME GATE



TECHNICAL INFO

REFERENCE

DOMEGTBCL
DOMEGTBSM
DOMEGTBAM
DOMEGTWCL
DOMEGTWSM
DOMEGTWAM

DIMENSIONS

WIDTH 30 CM
DEPTH 30 CM
HEIGHT 60 CM

MATERIALS



POWDER COATED ALUMINIUM
ANTHRACITE OR WHITE FRAME



HANDMADE GLASS
CLEAR / SMOKE / AMBER

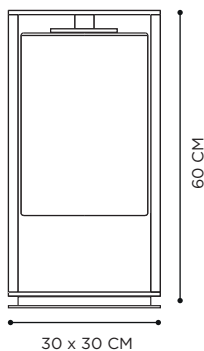

LIGHT SOURCE

LAMP 4W - DECORATIVE LED
FILAMENT BULB INCLUDED
POWER IN 230V - E27
LIGHT OUTPUT 280LM
COLOR TEMPERATURE 2200K
IP-RATING IP43

INSTALLATION OPTION JUB5625







DOME MOVE



TECHNICAL INFO

REFERENCE

DOMEMBCL
DOMEMBSM
DOMEMBAM
DOMEMWCL
DOMEMWSM
DOMEMWAM

DIMENSIONS

WIDTH 30 CM
DEPTH 30 CM
HEIGHT 112 CM

MATERIALS



POWDER COATED ALUMINIUM
ANTHRACITE OR WHITE FRAME



HANDMADE GLASS
CLEAR / SMOKE / AMBER

LIGHT SOURCE

LAMP 4W - DECORATIVE LED
FILAMENT BULB INCLUDED
POWER IN 230V - E27
LIGHT OUTPUT 280LM
COLOR TEMPERATURE 2200K
IP-RATING IP43

EXTRA

GALVANIZED STEEL BALLAST
CODE: 03DOMEMBALLAST01

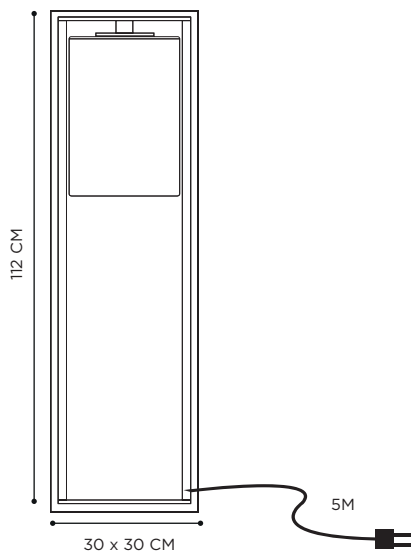

DOME SMALL



TECHNICAL INFO

REFERENCE

DOMESBCL
DOMESBSM
DOMESBAM
DOMESWCL
DOMESWSM
DOMESWAM

DIMENSIONS

WIDTH 30 CM
DEPTH 30 CM
HEIGHT 65 CM

MATERIALS



POWDER COATED ALUMINIUM
ANTHRACITE OR WHITE FRAME



HANDMADE GLASS
CLEAR / SMOKE / AMBER

LIGHT SOURCE

LAMP 4W - DECORATIVE LED
FILAMENT BULB INCLUDED
POWER IN 230V - E27
LIGHT OUTPUT 280LM
COLOR TEMPERATURE 2200K
IP-RATING IP43

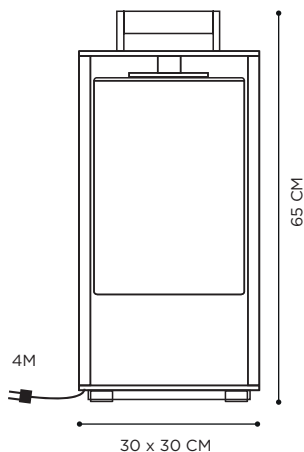



DOME WALL



TECHNICAL INFO

REFERENCE

DOMEWBCL
DOMEWBSM
DOMEWBAM
DOMEWWCL
DOMEWWSM
DOMEWWAM

DIMENSIONS

WIDTH 15 CM
DEPTH 20 CM
HEIGHT 65 CM

MATERIALS

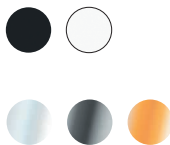

POWDER COATED ALUMINIUM
ANTHRACITE OR WHITE FRAME

HANDMADE GLASS
CLEAR / SMOKE / AMBER

LIGHT SOURCE

LAMP 4W - DECORATIVE LED
FILAMENT BULB INCLUDED
POWER IN 230V - E27
LIGHT OUTPUT 280LM
COLOR TEMPERATURE 2200K
IP-RATING IP43







DOME GLASS VARIETIES



FLOOR / WALL

03DOMG01

CLEAR



HAND MADE GLASS

03DOMG01SM

SMOKE



HAND MADE GLASS

03DOMG01AM

AMBER



HAND MADE GLASS

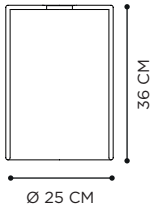

MOVE / SMALL / GATE

03DOMG02

CLEAR



HAND MADE GLASS

03DOMG02SM

SMOKE



HAND MADE GLASS



ELLIPSE WALL

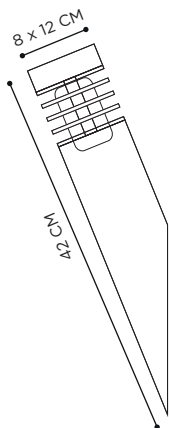

TECHNICAL INFO

REFERENCE

ELLW / ELLWL (LED)

DIMENSIONS

WIDTH	8 CM
DEPTH	12 CM
HEIGHT	42 CM

MATERIALS



TEAK + STAINLESS STEEL

RECOMMENDED LIGHT SOURCE

LAMP	LED / FLUO MAX. 11W
POWER IN	230V - E27
IP-RATING	IP55



LIGHT SOURCE FOR LED

LAMP	LED 8,5W
POWER IN	230V - 50 Hz
LIGHT OUTPUT	470LM
COLOR TEMPERATURE	3000K
IP-RATING	IP55

INSTALLATION OPTION JUB5625



MOSO GROUND



Ø 12 CM

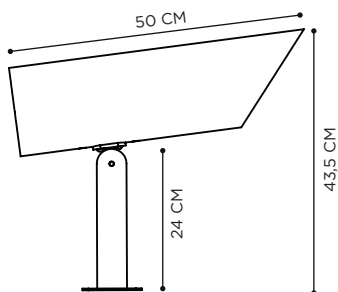
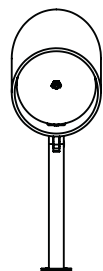

TECHNICAL INFO

REFERENCE

MSOGA

DIMENSIONS

WIDTH	Ø 12 CM
DEPTH	50 CM
HEIGHT	43,5 CM

MATERIALS



POWDER COATED ALUMINIUM
ANTHRACITE

LIGHT SOURCE

LAMP	LED 4,3W
POWER SUPPLY	500mA DRIVER INCLUDED IN FIXTURE
POWER IN	100-240V - 50/60Hz
LIGHT OUTPUT	700LM
COLOR TEMPERATURE	2700K
IP-RATING	IP65





MOSO WALL



TECHNICAL INFO

REFERENCE

MSOWUB *
MSOWDW *
MSOWDB *
MSOWDNB *

DIMENSIONS

WIDTH 10 CM
DEPTH 10 CM
HEIGHT 30 CM

MATERIALS



PORCELAIN
WHITE / BLACK / NIGHTBLUE

LIGHT SOURCE

LAMP LED 3W
POWER SUPPLY 350mA DRIVER INCLUDED
IN FIXTURE
POWER IN 100-240V - 50/60Hz
LIGHT OUTPUT 450LM
COLOR TEMPERATURE 2700K
IP-RATING IP65

EXTRA ADJUSTBLE BEAM
UP OR DOWN LIGHTER

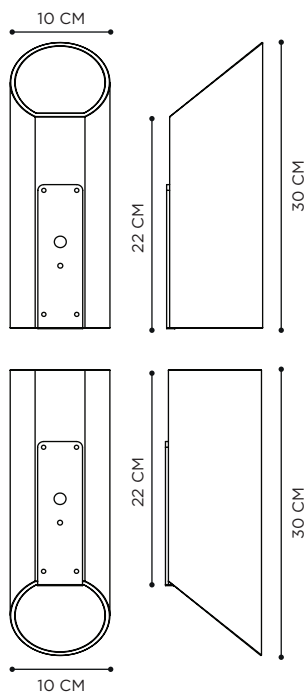





NEPTUNE

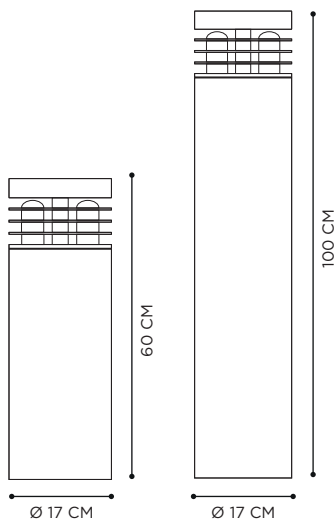

TECHNICAL INFO

REFERENCE

NPT60 / NPT60L (LED) *
NPT100 / NPT100L (LED) *

DIMENSIONS

WIDTH \varnothing 17 CM
DEPTH \varnothing 17 CM
HEIGHT 60 CM / 100 CM

MATERIALS



STAINLESS STEEL

RECOMMENDED LIGHT SOURCE

LAMP 3x LED / FLUO MAX. 11W
POWER IN 230V - E27
IP-RATING IP55

LIGHT SOURCE FOR LED

LAMP 3x LED 8,5W
POWER IN 230V - 50 Hz
LIGHT OUTPUT 470LM
COLOR TEMPERATURE 3000K
IP-RATING IP55

CONNECTION BOX INCLUDED







OMEGA



TECHNICAL INFO

REFERENCE

OMG1D220EP
OMG2D220EP

DIMENSIONS

WIDTH 8 CM
DEPTH 9,5 CM
HEIGHT 8 CM / 14,5 CM

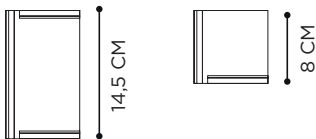
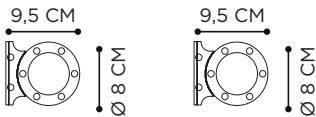

MATERIALS



ELECTROPOLISHED
STAINLESS STEEL

RECOMMENDED LIGHT SOURCE

LAMP LED 5W - GU10 FLAT OPTIC
POWER IN 230V
IP-RATING IP55





PARKER FLOOD

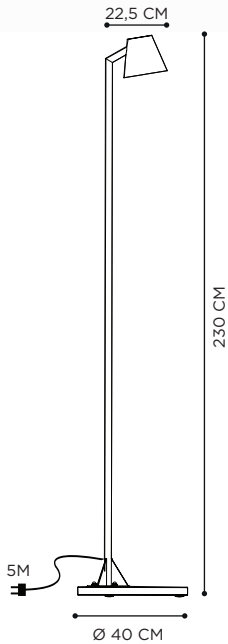

TECHNICAL INFO

REFERENCE

PRKF

DIMENSIONS

WIDTH	Ø 10 - 16 CM
DEPTH	22,5 CM
HEIGHT	230 CM

MATERIALS



ANTIQUE BRASS

LIGHT SOURCE

LAMP	LED 3W
POWER SUPPLY	350mA DRIVER INCLUDED IN FIXTURE
POWER IN	100-240V - 50/60Hz
LIGHT OUTPUT	450LM
IP-RATING	IP65

EXTRAS

GRANITE BASE Ø 40 CM
INCLUDED









PARKER PATH

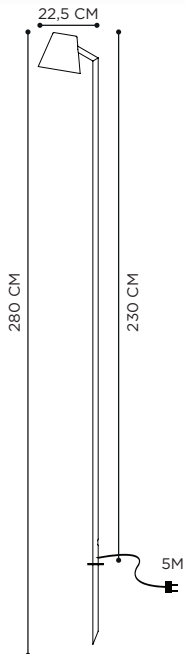

TECHNICAL INFO

REFERENCE

PRKP

DIMENSIONS

WIDTH Ø 10 - 16 CM
DEPTH 22,5 CM
HEIGHT 230 CM

MATERIALS



ANTIQUE BRASS

LIGHT SOURCE

LAMP LED 3W
POWER SUPPLY 350mA DRIVER INCLUDED
IN FIXTURE
POWER IN 100-240V - 50/60Hz
LIGHT OUTPUT 450LM
IP-RATING IP65

EXTRAS

SPIKE INCLUDED







PARKER WALL



TECHNICAL INFO

REFERENCE

PRKW

DIMENSIONS

WIDTH	Ø 10 - 16 CM
DEPTH	25 CM
HEIGHT	42 CM

MATERIALS



ANTIQUE BRASS

LIGHT SOURCE

LAMP	LED 3W
POWER SUPPLY	350mA DRIVER INCLUDED IN FIXTURE
POWER IN	100-240V - 50/60Hz
LIGHT OUTPUT	450LM
IP-RATING	IP65

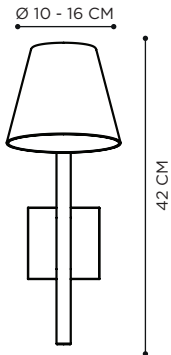

Q-BIC WALL



TECHNICAL INFO

REFERENCE

QBW1D220EP *
QBW2D220EP *

DIMENSIONS

WIDTH 7,5 CM
DEPTH 12,5 CM
HEIGHT 10 - 20 CM

MATERIALS



TEAK + ELECTROPOLISHED
STAINLESS STEEL

RECOMMENDED LIGHT SOURCE

LAMP LED 5W - GU10 FLAT OPTIC
POWER IN 230V
IP-RATING IP55

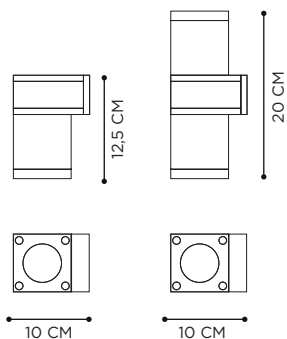



ROPY

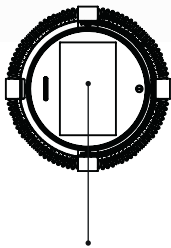

SOLAR LAMP

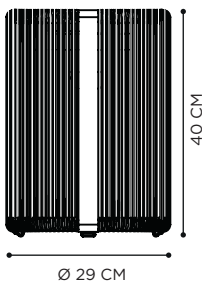

TECHNICAL INFO

REFERENCE

RPY040AB
RPY040GG
RPY040SD

DIMENSIONS

WIDTH Ø 29 CM
DEPTH Ø 29 CM
HEIGHT 40 CM

MATERIALS



POWDER COATED ALUMINIUM
ANTHRACITE + POLYOLEFIN ROPE
BRONZE



POWDER COATED ALUMINIUM
GREEN + POLYOLEFIN ROPE GREEN



POWDER COATED ALUMINIUM
SAND + POLYOLEFIN ROPE DESERT

LIGHT SOURCE SOLAR

LAMP SOLAR LED 2,6W
RECHARGEABLE VIA USB

LIGHT OUTPUT 400LM
COLOR TEMPERATURE 2700K
IP-RATING IP65



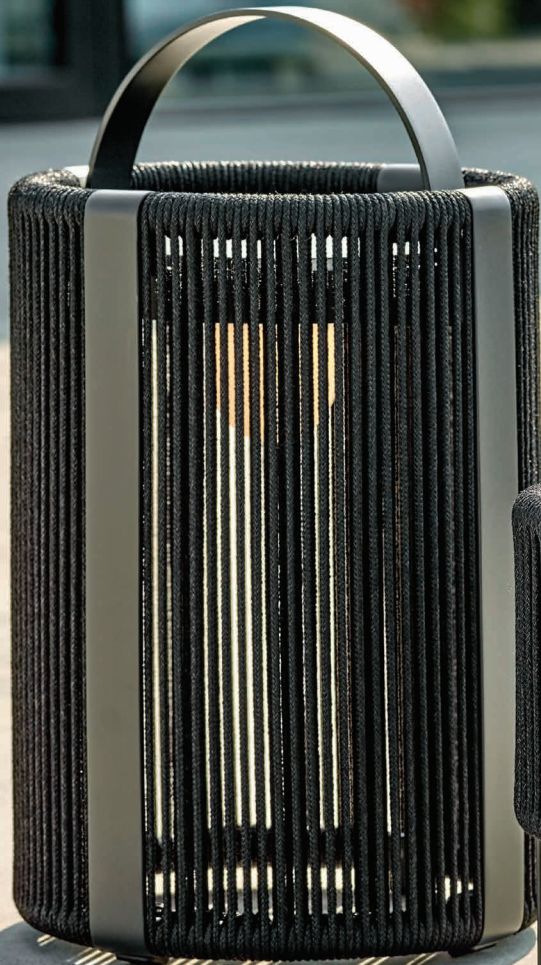

ROPY TABLE

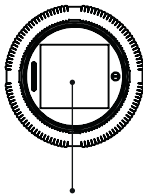

SOLAR LAMP

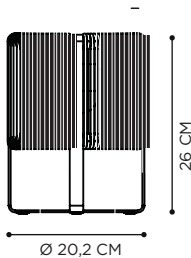

TECHNICAL INFO

REFERENCE

RPYTBAB
RPYTBGG
RPYTBSD

DIMENSIONS

WIDTH Ø 20,2 CM
DEPTH Ø 20,2 CM
HEIGHT 26 CM

MATERIALS



POWDER COATED ALUMINIUM
ANTHRACITE + POLYOLEFIN ROPE
BRONZE



POWDER COATED ALUMINIUM
GREEN + POLYOLEFIN ROPE GREEN



POWDER COATED ALUMINIUM
SAND + POLYOLEFIN ROPE DESERT

LIGHT SOURCE SOLAR

LAMP SOLAR LED 1W
RECHARGEABLE VIA USB
LIGHT OUTPUT 150LM
COLOR TEMPERATURE 2700K
IP-RATING IP65











RUSTY



TECHNICAL INFO

REFERENCE

RUS40 / RUS40L (LED)
RUS70 / RUS70L (LED)

DIMENSIONS

WIDTH Ø 13 CM
DEPTH Ø 19 CM
HEIGHT 40 CM / 70 CM

MATERIALS



CAST IRON

RECOMMENDED LIGHT SOURCE

LAMP LED / FLUO MAX. 11W
POWER IN 230V - E27
IP-RATING IP55

LIGHT SOURCE FOR LED

LAMP LED 8,5W
POWER IN 230V - 50 Hz
LIGHT OUTPUT 470LM
COLOR TEMPERATURE 3000K
IP-RATING IP55

INSTALLATION OPTION JUB5625

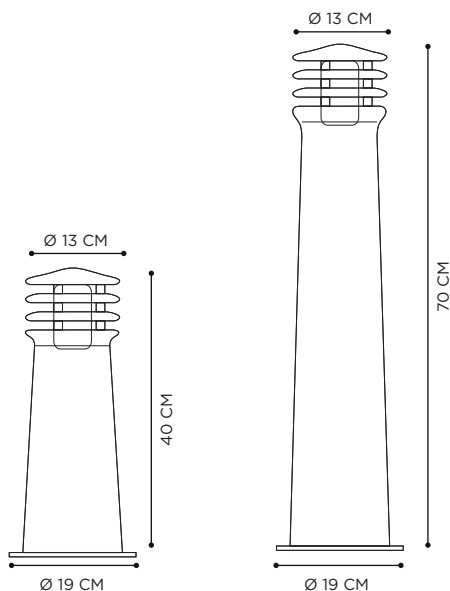



SPIKY



TECHNICAL INFO

REFERENCE

SPKG
SPK

DIMENSIONS

WIDTH Ø 1,3 CM
DEPTH 10 CM
HEIGHT 40 CM - 100 CM

MATERIALS



ANTIQUÉ BRASS

LIGHT SOURCE

LAMP POWERLED 3W
LIGHT OUTPUT 450LM
COLOR TEMPERATURE 2700K
IP-RATING IP65
REQUIRED LEDCONKIT OR DR11

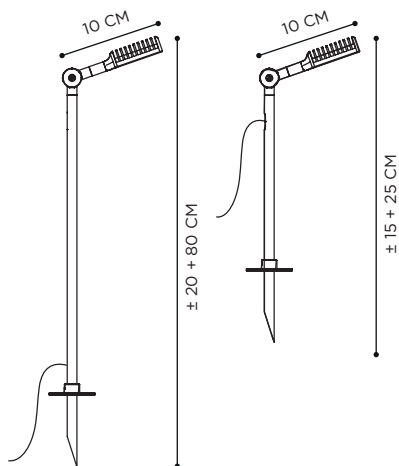



SPIKY LOUNGE



TECHNICAL INFO

REFERENCE

SPL *

DIMENSIONS

WIDTH	36 CM
DEPTH	± 36 CM
HEIGHT	± 100 CM

MATERIALS



ANTIQUE BRASS

LIGHT SOURCE

LAMP	POWERLED 3W
POWER SUPPLY	350mA DRIVER INCLUDED IN FIXTURE
POWER IN	100-240V - 50/60Hz
LIGHT OUTPUT	450LM
COLOR TEMPERATURE	2700K
IP-RATING	IP65

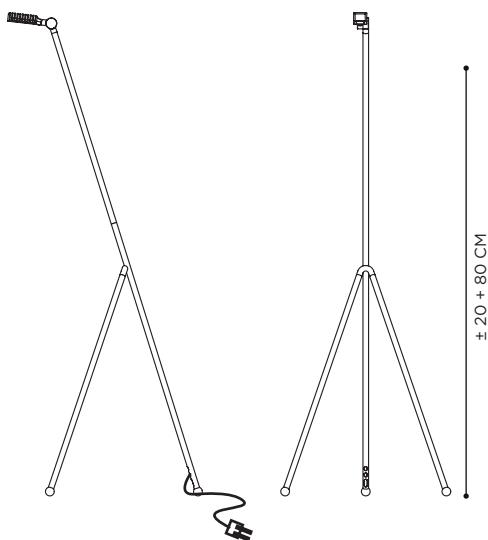

SPOTTY SPIKE



TECHNICAL INFO

REFERENCE

SPTHBR * +
SPTS060BR * / SPTS120BR *

DIMENSIONS

WIDTH 9 CM
HEIGHT 60 CM / 120 CM

MATERIALS



POWDER COATED ALUMINIUM
BRONZE

LIGHT SOURCE

LAMP LED 3W
LIGHT OUTPUT 500LM
COLOR TEMPERATURE 2700K
IP-RATING IP65

REQUIRED LEDCONKIT OR DRI1

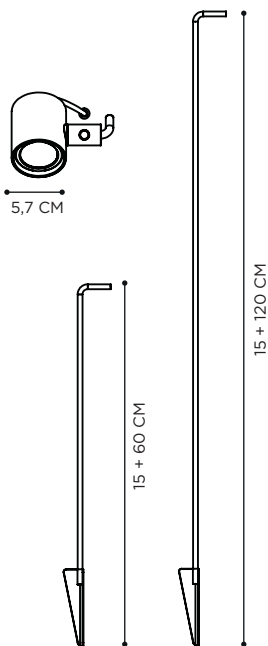







SPOTTY WALL



TECHNICAL INFO

REFERENCE

SPTWBR *

DIMENSIONS

HEIGHT

9 CM

MATERIALS



POWDER COATED ALUMINIUM
BRONZE

LIGHT SOURCE

LAMP

LED 3W

LIGHT OUTPUT

500LM

COLOR TEMPERATURE

2700K

IP-RATING

IP65

POWER SUPPLY

350MA DRIVER INCLUDED
IN FIXTURE

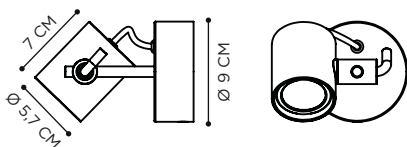





TESLA CEILING



TECHNICAL INFO

REFERENCE

TSLCA

DIMENSIONS

WIDTH	15 CM
DEPTH	15 CM
HEIGHT	25 CM

MATERIALS



POWDER COATED ALUMINIUM
ANTHRACITE + HANDMADE
CLEAR GLASS

LIGHT SOURCE

LAMP	4W - DECORATIVE LED FILAMENT BULB INCLUDED
POWER IN	230V - E27
LIGHT OUTPUT	280LM
COLOR TEMPERATURE	2200K
IP-RATING	IP43

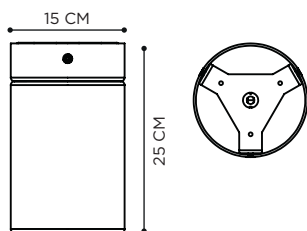







TESLA WALL



TECHNICAL INFO

REFERENCE

TSLWA

DIMENSIONS

WIDTH	15 CM
DEPTH	16 CM
HEIGHT	25 CM

MATERIALS



POWDER COATED ALUMINIUM
ANTHRACITE + HANDMADE
CLEAR GLASS

LIGHT SOURCE

LAMP	4W - DECORATIVE LED FILAMENT BULB INCLUDED
POWER IN	230V - E27
LIGHT OUTPUT	280LM
COLOR TEMPERATURE	2200K
IP-RATING	IP43

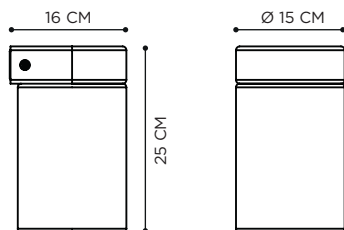

TRISTAR



TECHNICAL INFO

REFERENCE

TRS045
TRS050

DIMENSIONS

WIDTH 24,5/29,5 CM
DEPTH 24,5/29,5 CM
HEIGHT 40CM/50 CM

MATERIALS



TEAK



HANDMADE GLASS
OPAL / SMOKE

LIGHT SOURCE

LAMP 4W - DECORATIVE LED
FILAMENT BULB INCLUDED
POWER IN 230V - E27
LIGHT OUTPUT 280LM
COLOR TEMPERATURE 2200K
IP-RATING IP43

EXTRAS

CABLE 6,5 METER

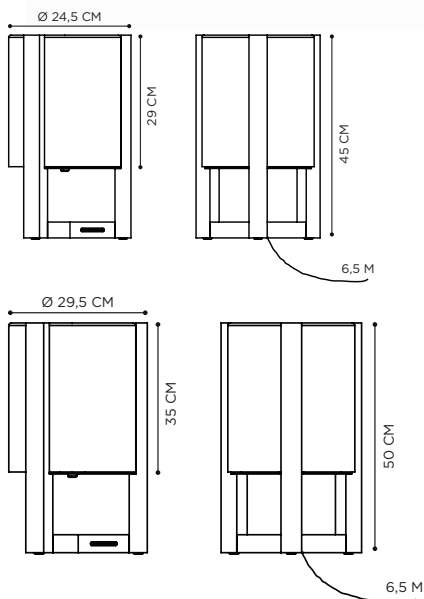



TRISTAR ALU



TECHNICAL INFO

REFERENCE

TRS045A
TRS045WR
TRS050A
TRS050WR

DIMENSIONS

WIDTH 24,5/29,5 CM
DEPTH 24,5/29,5 CM
HEIGHT 40CM/50 CM

MATERIALS

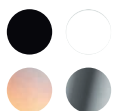

POWDER COATED ALUMINIUM
ANTHRACITE OR WHITE FRAME
HANDMADE GLASS
OPAL / SMOKE

LIGHT SOURCE

LAMP 4W - DECORATIVE LED
FILAMENT BULB INCLUDED
POWER IN 230V - E27
LIGHT OUTPUT 280LM
COLOR TEMPERATURE 2200K
IP-RATING IP43

EXTRAS CABLE 6,5 METER

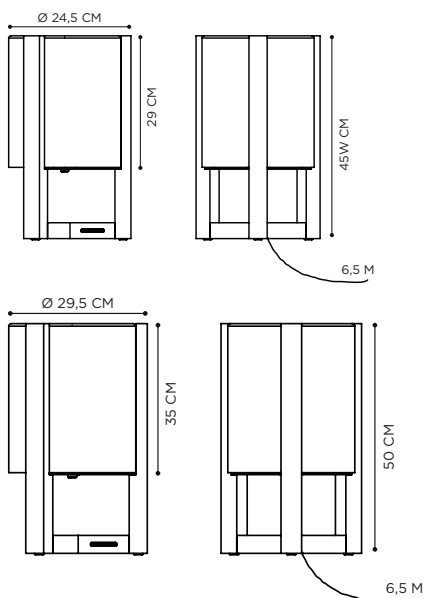









ACCESSORIES

LIGB	STAINLESS STEEL SPIKE: LIGHTHOUSE / NORTHPOLE / ELLIPSE / IRONY	
LBN	STAINLESS STEEL SPIKE: Q-BIC 30/60 / TWIN / MOSO GROUND / NON-SIDE	
LBQ	STAINLESS STEEL SPIKE: Q-BIC GROUND / Q-BIC WALL / NON	
LBNPT	STAINLESS STEEL SPIKE: NEPTUNE	
LBD	GALVANISED STEEL SPIKE: DOME FLOOR	
LBDM	GALVANISED STEEL SPIKE: DOME MOVE	
LBL	STAINLESS STEEL SPIKE: LOG	
LBR	GALVANISED STEEL SPIKE: RUSTY	
BL360	PERFORATED SCREEN 360° - STAINLESS STEEL	
BL180	PERFORATED SCREEN 180° - STAINLESS STEEL	
BINLS	LED INSERT FOR NEW OR REPLACEMENT FIXTURES LED 8,5W - 470lm - 3000K - 230V / 50Hz	CE IP55 
BINLR	LED INSERT FOR NEW OR REPLACEMENT FIXTURES WITH VARIOUS LIGHTOUTPUT LED 2,2W - 390lm UP TO 4,3W - 700lm - 2700K (For more info: Please contact your Royal Botania Dealer)	CE IP55
BIN2	E27 LAMP HOLDER - 220V/E27 - LED FLUO MAX 11W	CE IP55 
LEDCONKIT	= DRI1 + JUB5625 + JUB5630	
DRI1	IP68 LED DRIVER 100-220V 50-60HZ - 350mA - 9W	CE IP68
JUB5625	CONNECTION BOX IP68 - 3X4 mm ²	CE IP68
JUB5630	JUNCTION BOX IP68 - 2X1,5 mm ²	CE IP68
OPTIONAL BULB FOR TESLA / CLOCHE WALL / DOME COLLECTION		CE 
LTLED04WE27	LED FILAMENT BULB 3W - 220V/E27 - 2200K - 300lm	

MATERIALS



STAINLESS STEEL

Stainless steel, better known as Inox is an iron alloy in which the resistance to corrosion is increased through the addition of chrome and nickel. The principle involves the protection of the outside surface by chromium oxide and nickel oxide molecules. These molecules are much bigger than the underlying iron atoms, which prevents the latter from combining with oxygen to form iron oxides – better known as rust. This passive layer protects the precious steel and is self-renewing. In order to obtain a chromium- and nickel oxide skin that is as pure and homogeneous as possible, and therefore optimally corrosion-resistant, the standard Royal Botania frames are etched and rinsed with demineralised water after which a passive layer is formed by natural oxidation. Chlorine is the biggest enemy of stainless steel and can cause a form of corrosion known as “pitting”. Contamination by chlorides or rusting particles can penetrate the passive layer and cause corrosion in certain places. This is especially important when near the sea, because of course sea salt is sodium chloride. It is necessary to give the metal as smooth a surface as possible in order to give it an even greater resistance to corrosion. This is because if the surface is smooth, there is less chance for contamination to take hold on the metal surface, thus reducing possible corrosion.

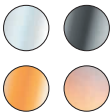

GLASS

Royal Botania offers 4 varieties of coloured glass: clear, smoke, amber and opal. All handmade and highly suitable for outdoor use.



POWDER COATED ALUMINIUM

Aluminium is a non-ferrous metal, which combines great mechanical rigidity with light weight; this makes it especially suitable for making outdoor lighting. If treated correctly it has a good resistance to corrosion. One of the treatments is powdercoating. After a chemical pre-treatment an epoxy powder is applied electrostatically and baked. The advantages are easy cleaning and endless colour variations. Powdercoating is a type of coating that is applied as a free flowing, dry powder. The coating is typically applied electrostatically and is then cured under heat to allow it to flow and form a “skin”. Powdercoating provides excellent protection against corrosion.



(ANTIQUÉ) BRASS

Brass is an alloy of copper and zinc. The darker finish (antique brass) is achieved by dipping the brass in acid, which gives it an antique look.

MATERIALS



TEAK

Because Royal Botania makes no concessions when it comes to quality, we only use carefully selected, fully grown teak, which is harvested in accordance with the strictest environmental standards. The wood comes from the *Tectona Grandis*, a tree that can grow to a height of 45m under the right conditions with a trunk diameter of up to 2.4 metres. The reason for its generally commended durability is the high levels of natural oils it contains. The resulting minimal moisture absorption prevents warping which gives it great stability. Moreover, the wood is extremely resistant to the influences of chemicals, as well as against attacks by vermin. Because of these qualities, combined with its exceptionally-beautiful colour and structure, teak is classed as the most premium wood on our precious planet.



CORIAN®

Corian® is a 'solid surface' material made of mass-dyed composite material, they combine mass with homogeneity, yet without seams or joints. The basic ingredient of this product is aluminium trihydrate (ATH). Other components are acrylic resins, which are used as a binder. Aluminium hydroxide makes the material very sturdy and also more heat-resistant than other synthetic materials. 5 good reasons for choosing this material: 1. hard-wearing 2. non-porous 3. hygienic 4. impact-resistant 5. uV-resistant.



ZINC

The zinc alloy used to manufacture Royal Botania lighting will look white in colour when first installed in the landscape. This is due to the acidification of the zinc oxide. At a later stage, this white deposit will wash off and will turn into a lovely darkgrey patina.



PORCELAIN

Porcelain, refined and produced with modern and sophisticated techniques remains stable in all temperatures. It's extremely hard, wear-resistant and colorfast. This sustainable and lifelong porcelain is very suitable for indoor- and outdoor use.



CAST IRON

Royal Botania uses a cast iron alloy with a small percentage of copper and chrome. This prevents any layer of oxidation created by contact with air and water from flaking off. The result is an even, rust-coloured patina that blends in perfectly with the natural surroundings.



GRANITE

Royal Botania uses solid granite. Granite is one of the hardest types of stone in the world. The unusual pattern and structure of the stone gives every bollard its own special look and character. simply clean with water and natural soap.



POLYETHYLENE

PE, or Polyethylene, is a thermoplastic polymer consisting of long hydrocarbon chains which is very durable and ideal for outdoor use.



PVC COVERED FIBREGLASS

The PVC covered fiber provides a solid core. This material requires a strong tensile and tear strengths, waterproofing, and heat and mildew resistance.



3D FABRIC

Made of synthetic fibers with a spacer layer of polyester microfilaments, absorbs little water and dries very fast in open air.



ARABESCATO CARRARA

The translucent material highlights the natural beauty of marble.



POLYOLEFIN

This is a synthetic fibre made from polyethylene. The advantage of this fibre is its strength, colour fastness. Also it is very resistant to staining and different weather conditions.

















OUTDOOR FURNITURE CATALOGUE

ASK YOUR DEALER FOR THE COMPLETE OUTDOOR FURNITURE CATALOGUE
OR DOWNLOAD IT ON OUR WEBSITE: **WWW.ROYALBOTANIA.COM**



ROYAL 
BOTANIA
indulge in finesse